



# METPAR STAINLESS STEEL TOILET ENCLOSURES

## The Dorian – Type F/C-FP/CH-D - Floor-To-Ceiling

### *Privacy Style*

**MATERIALS:** Stainless Steel #301/304 series in #4 finish

**THICKNESS:** Doors..... 22 Gauge, Finished to 1" (25mm) at 64" (1626) high  
Panels..... 22 Gauge, Finished to 1" (25mm) at 64" (1626) high  
Pilasters..... 20 Gauge, Finished to 1¼" (32mm) various heights

### **CONSTRUCTION:**

#### Doors:

Finished to 1" (25) thick, constructed of two sheets of 22-gauge stainless steel formed and cemented under pressure to a honeycomb core. Door face sheets are welded at intervals around the entire perimeter. All edges to be finished with a 20-gauge stainless steel interlocking molding. Corners are finished with pre-formed stainless steel reinforcements. Doors shall have internal steel reinforcements to secure hardware items.

#### Panels:

Finished to 1" (25) thick, constructed of 2 sheets of 22-gauge stainless steel, formed and cemented under pressure to a honeycomb core. All partition edges are finished with a 20-gauge stainless steel interlocking molding. Corners will be finished with pre-formed stainless steel reinforcements.

#### Pilasters:

Finished to 1¼" (32) thick, constructed of two sheets of 20-gauge, stainless steel, formed and assembled with a honeycomb core. Face sheets are electrically welded at intervals around the entire perimeter. All pilasters will have a 4" (102) high #4 finish stainless steel plinth and have straight, flat sides profile with rounded edges to match the pilaster profile. Pilasters will have leveling bolts threaded to the pilaster bottom support bracket and mounted with #12 x 2½" (64) screws and shields at the floor. Ceiling mounting channels are 12-gauge steel formed and electrically welded to the pilaster face sheets. Zinc plated 3/8" (10) diameter studs, lock washers and nuts are provided for top mounting.

### **BRACKETS:**

Attachment brackets are full height clear anodized aluminum U-Channels for panel-to-pilaster conditions and 1" x 2¼" angles elsewhere.

### **DOOR HARDWARE:**

Each compartment will be complete with two door hinges, latch, stop and keeper, coat hook, as well as all necessary fittings and fastenings for a complete installation. Hinges are fastened by means of tamper-proof Torx Pin Head through bolts, which are polished chrome plated. All other screws to be tamper-proof Torx Pin Head chrome plated. Doors are to be hung on a concealed, "stay-set", fully adjustable, non-rising door mechanism. Upper hinge pin shall be 3/8" (10) diameter steel. All hinges will have wrap-around flanges with a minimum of 5/8" (16) wrap onto pilaster. All doors will have a concealed ADA approved slide latch with external "in-use" indicator. A continuous anodized aluminum extrusion is provided for both strike & hinge sides to eliminate gaps between door & pilaster.

### **FINISH:**

All stainless steel partitions are supplied with high strength 300 series alloys in a #4 finish. Optional 2B leathergrain and 5SM diamond pattern textured finishes are also available.

### **OPTIONS:**

Full height stainless steel angles & U-Channels. Full height stainless steel MutliCam® hinges. Cast S/S wraparound hinges with matching surface latch, S&K. Other special heights or special elevations AFF.



95 State Street, Westbury, New York USA 11590

Tel: 516-333-2600 ~ Fax: 516-333-2618

[www.Metpar.com](http://www.Metpar.com) ~ [Sales@Metpar.com](mailto:Sales@Metpar.com)

DIMENSIONS IN ( ) = MILLIMETERS

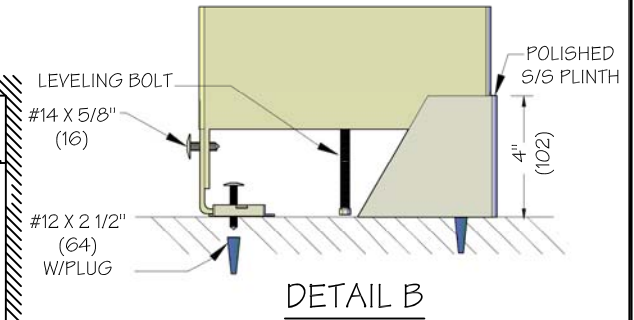
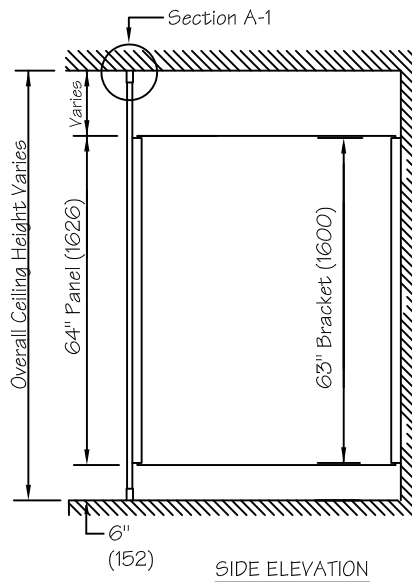
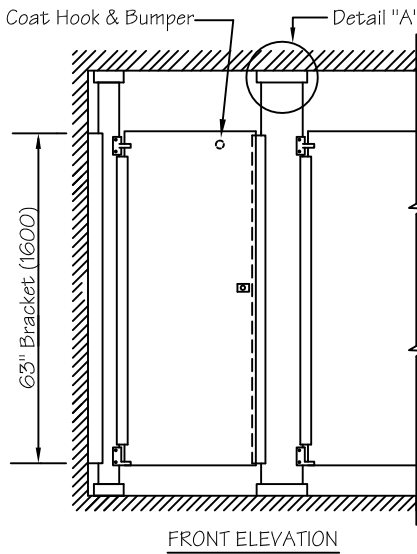
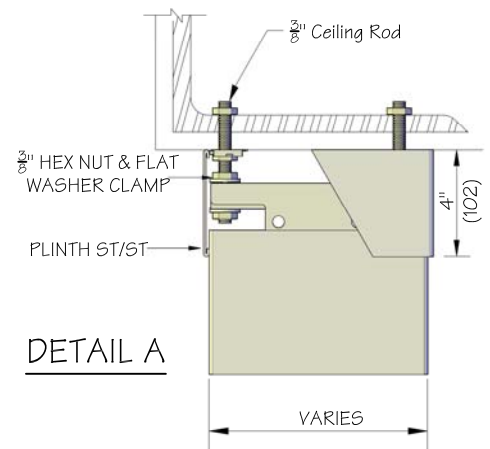
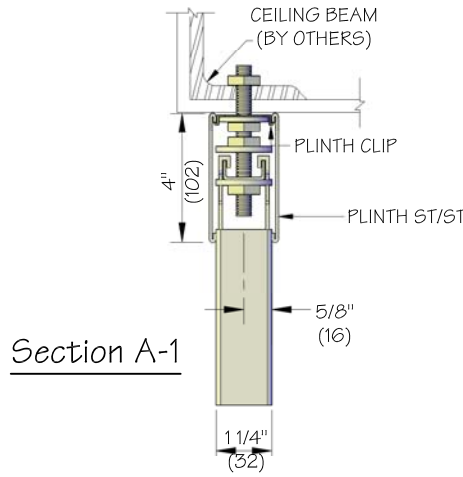
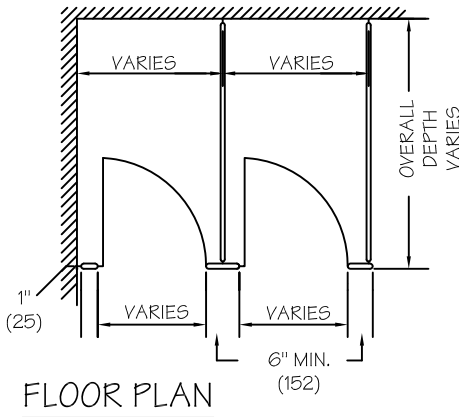

**NOTE:** This drawing is a standard detail intended to show general construction and specification. See shop drawing(s) for actual job layouts and specific job conditions that supercede any conflicting information on this detail sheet. Blocking (by others) or adequate support within wall required to support full length brackets.

\*Concealed Latch w/ "In-Use" Indicator - Elevation 42" AFF unless otherwise specified.

#12 x 2 1/2" (64) S/S Sheet Metal Fastener w/PLUG

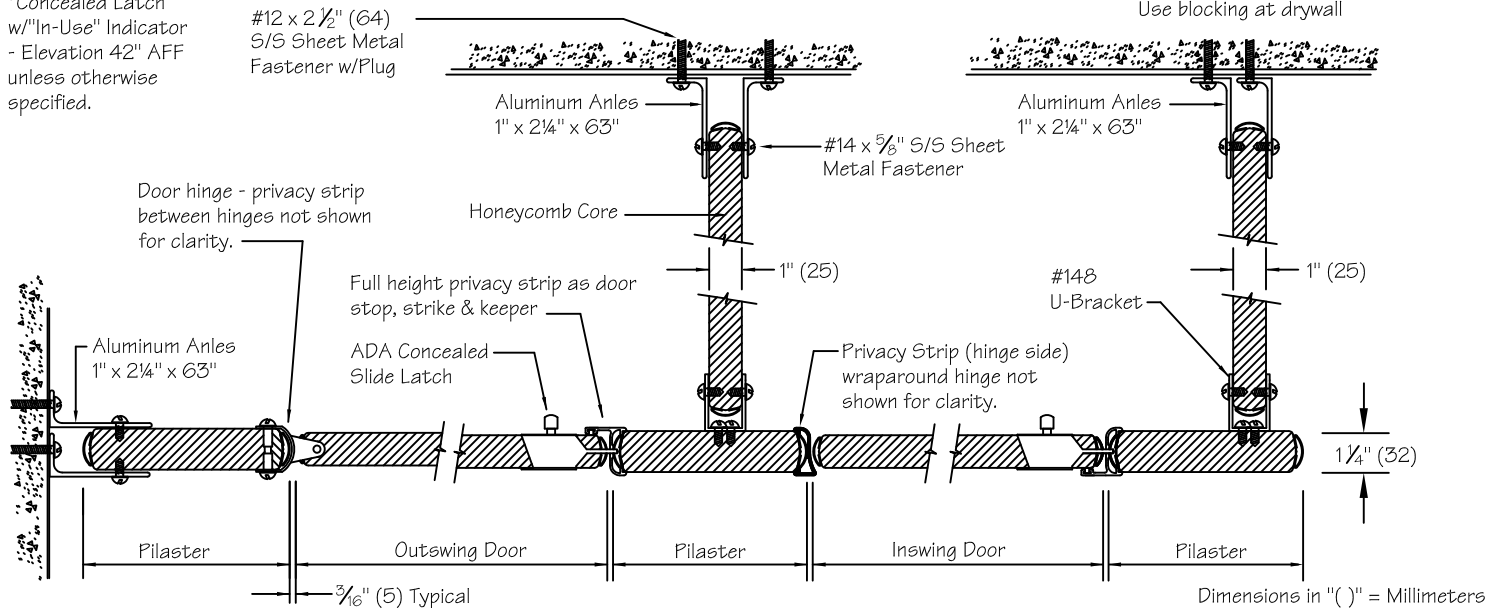

**METPAR CORP**

95 State Street, Westbury, NY 11590

Tel: 516-333-2600 Fax: 516-333-2618

www.Metpar.com ~ Sales@Metpar.com

**STAINLESS STEEL**

Special Detail FP Bottom CH Top Floor To Ceiling Dorian Style w/Full Privacy

FCFPCHSSD.dwg

05-04-20